

Add Buiding 18th, No.177 FuLian 2nd Road, BaoShan District, Shanghai

Tel 021-54851801

Net www.panelmate.cn

Product Manuals

About PanelMate

Shanghai PanelMate Electronics Co.,Ltd is a domestic technology enterprise focusing on industrial display, industrial panel pc, arm-mounted hmi panel pc, box pc, cnc control panel, hand-held pendant station, industrial keyboard and automatic control system integration.

Our company is committed to providing packaged solutions for key components selection, circuit design, appearance design, production, sales and after sales services from product design and development to assembly according to customer requirements.

Our company has professional software and hardware development capabilities, and the cnc control panel can support EtherCAT, Modbus-TCP, CANBUS, PROFINET, ADS and other bus protocols.

Relying on the founder and team's research and summary of the integration service experience in various industries, the products are widely used in printing and packaging, textile machinery, testing equipment, construction machinery, high-speed rail, currency machinery, tobacco machinery, advanced numerical control system, Industry 4.0 and other related fields.

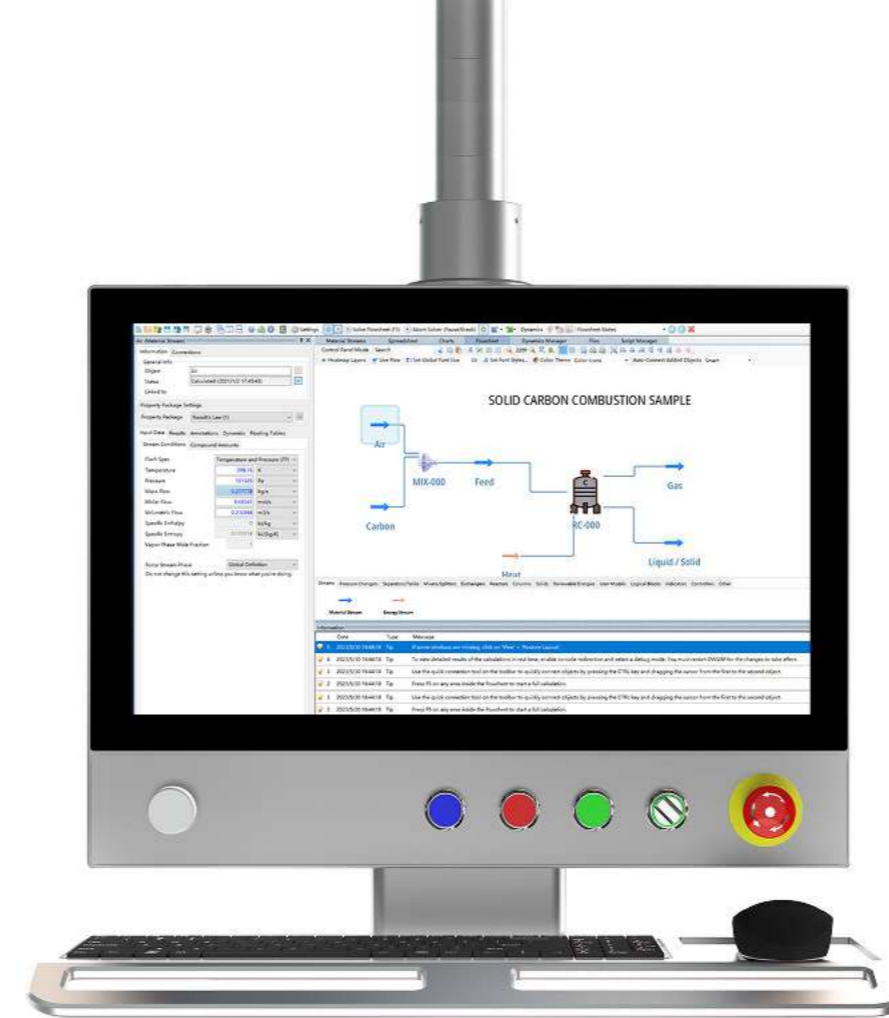

PANELMATE
Creative HMI Solution

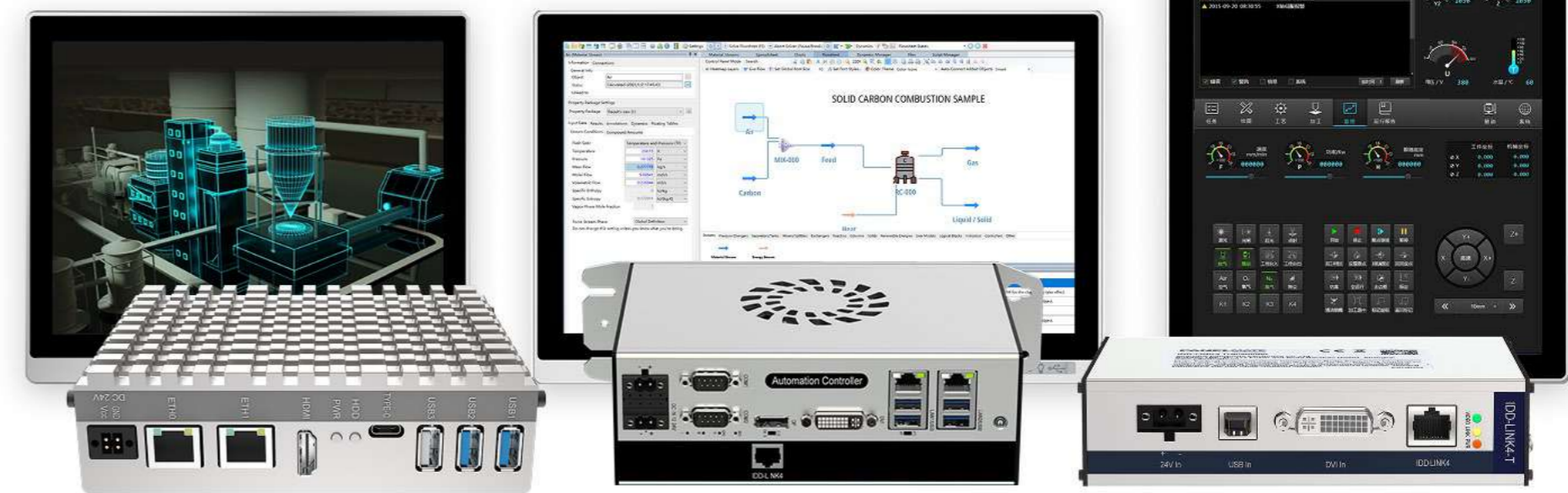

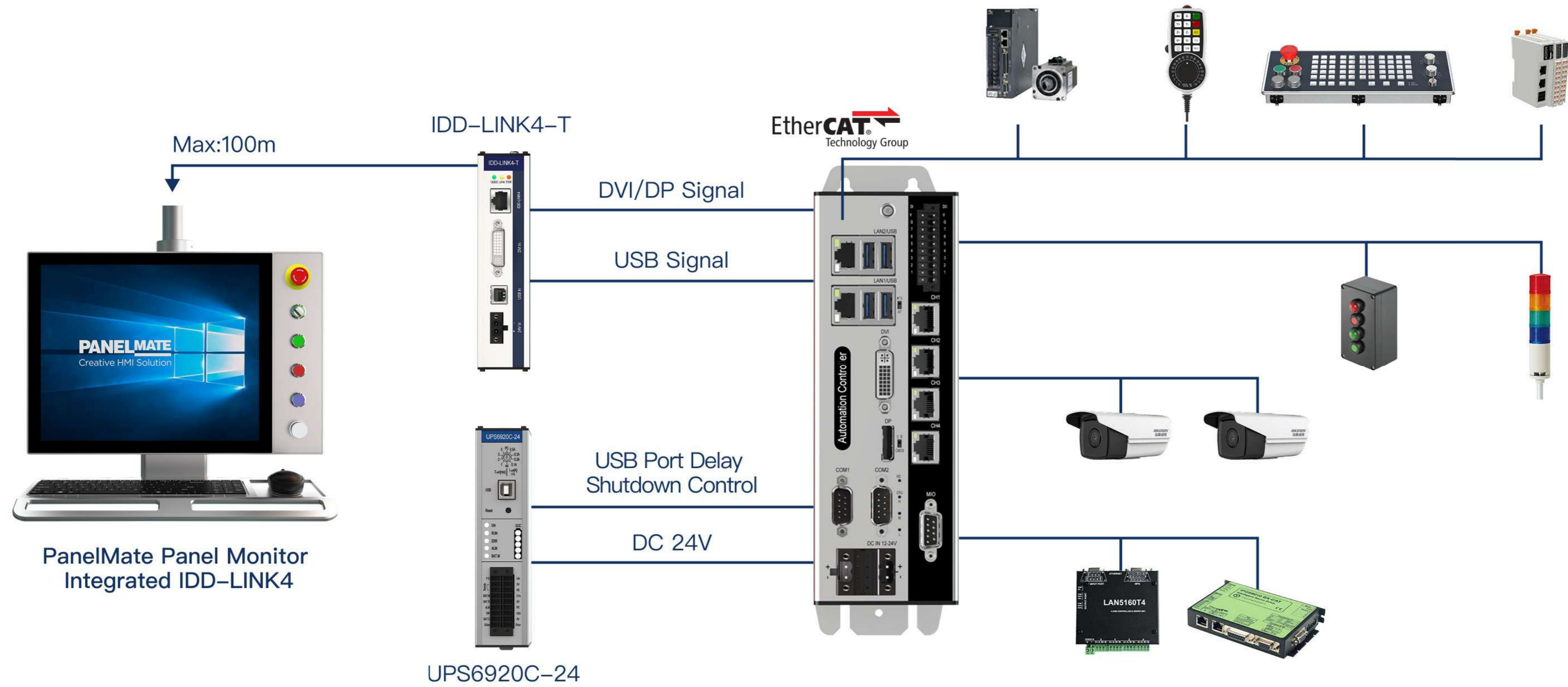

Machine Vision Solutions

Contents

01

PANELMATE Products

02

PANELMATE Projects

03

Value and Service

New Product

Recessed-mounted HMI



Recessed-mounted capacitive touch Monitor



Recessed-mounted capacitive touch Panel PC 

Recessed-mounted Industrial Monitor



- **Robust Design For Industrialization**
All Aluminum Magnesium Alloy Shell Design, Modular Display
- **Multiple Size Options**
12.1" To 24" , 7 Sizes Available, Include Landscape、Portrait and Wide Screen
- **Front IP66**
Prevent Splashing And Dust In The Working Environment
- **Safety Wide Voltage Power Supply**
DC 12~36V
- **Industry Certified**
CE, FCC And RoHS Certification
- **Multiple Operating System**
Windows7, Window8, Windows10, Windows11, Linux, etc
- **Capacitive Touch**
Accurate 10-point touch



**Triple-Certified
Guaranteed Explosion-Proof**

Recessed-mounted Industrial Panel PC



PANELMATE
Creative HMI Solution

- **Robust Design For Industrialization**

All Aluminum Magnesium Alloy Shell Design, Modular Display

- **Multiple Size Options**

12.1" To 24" , 7 Sizes Available, Include Landscape、Portrait and Wide Screen

- **Front IP66**

Prevent Splashing And Dust In The Working Environment

- **Real-Time Data Exchange**

Expandable WIFI, 4G Network

- **Industry Certified**

CE, FCC And RoHS Certification

- **Multiple Operating System**

Windows7, Window8, Windows10, Windows11, Linux, etc

- **Capacitive Touch**

Accurate 10-point touch

- **Storage And HDD**

RAM: DDR4 Max 64GB

SSD : 64GB~1T

- **Superior Performance Supported By Intel®**

Intel® Celeron® J6412

Intel® Core™ 6/7/10/11/12/13th i3 i5 i7



**Triple-Certified
Guaranteed Explosion-Proof**

*product parameter please contact sales or engineers to obtain product datasheet

New Product

Stainless Steel Explosion-Proof Series



Monitor



Embedded Stainless Steel Explosion-Proof Capacitive Touch Monitor



Arm-Mounted Stainless Steel Explosion-Proof Capacitive Touch Monitor

Panel PC



Embedded Stainless Steel Explosion-Proof Capacitive Touch Panel PC 



Arm-Mounted Stainless Steel Explosion-Proof Capacitive Touch Panel PC 

Embedded Stainless Steel ATEX Industrial Monitor

- **The Best Solution For Explosion-Proof Environments**

Passed The ATEX-Ex Protection Certificate

- **Multiple Size Options**

7 Sizes Include Landscape, Portrait and Wide Screen

- **Stainless Steel Rounded Flat Panel Design**

Front: 304 Stainless Steel, Easy To Clean And Maintain

- **Meet Strict Hygiene Requirements**

Ideal For Food, Packaging And Pharmaceutical Applications

- **Front Panel/Rear IP66**

Explosive And Other Harsh Hazardous Environment

- **Capacitive Touch**

Accurate 10-point touch

- **Multiple Operating System**

Windows7, Window8, Windows10, Windows11, Linux, etc



**Triple-Certified
Guaranteed Explosion-Proof**

Embedded stainless steel ATEX Industrial Panel PC



PANELMATE
Creative HMI Solution

- **The Best Solution For Explosion-Proof Environments**

Passed The ATEX-Ex Protection Certificate

- **Multiple Size Options**

7 Sizes Include Landscape, Portrait and Wide Screen

- **Stainless Steel Rounded Flat Panel Design**

Front: 304 Stainless Steel, Easy To Clean And Maintain

- **Meet Strict Hygiene Requirements**

Ideal For Food, Packaging And Pharmaceutical Applications

- **Real-Time Data Exchange**

Expandable WIFI, 4G Network

- **Multiple Operating System**

Win7, Win8, Win10, Win11, Linux, etc

- **Excellent Touch Experience**

Multi-Point Capacitive Touch For Easy Touch In Harsh Environments

- **Storage And HDD**

RAM: DDR4 Max 32GB

SSD : 64GB~1T

- **Superior Performance Supported By Intel®**

Intel® Celeron® 3855U/3865U

Intel® Core™ 6/7th i3 i5 i7



Triple-Certified
Guaranteed Explosion-Proof

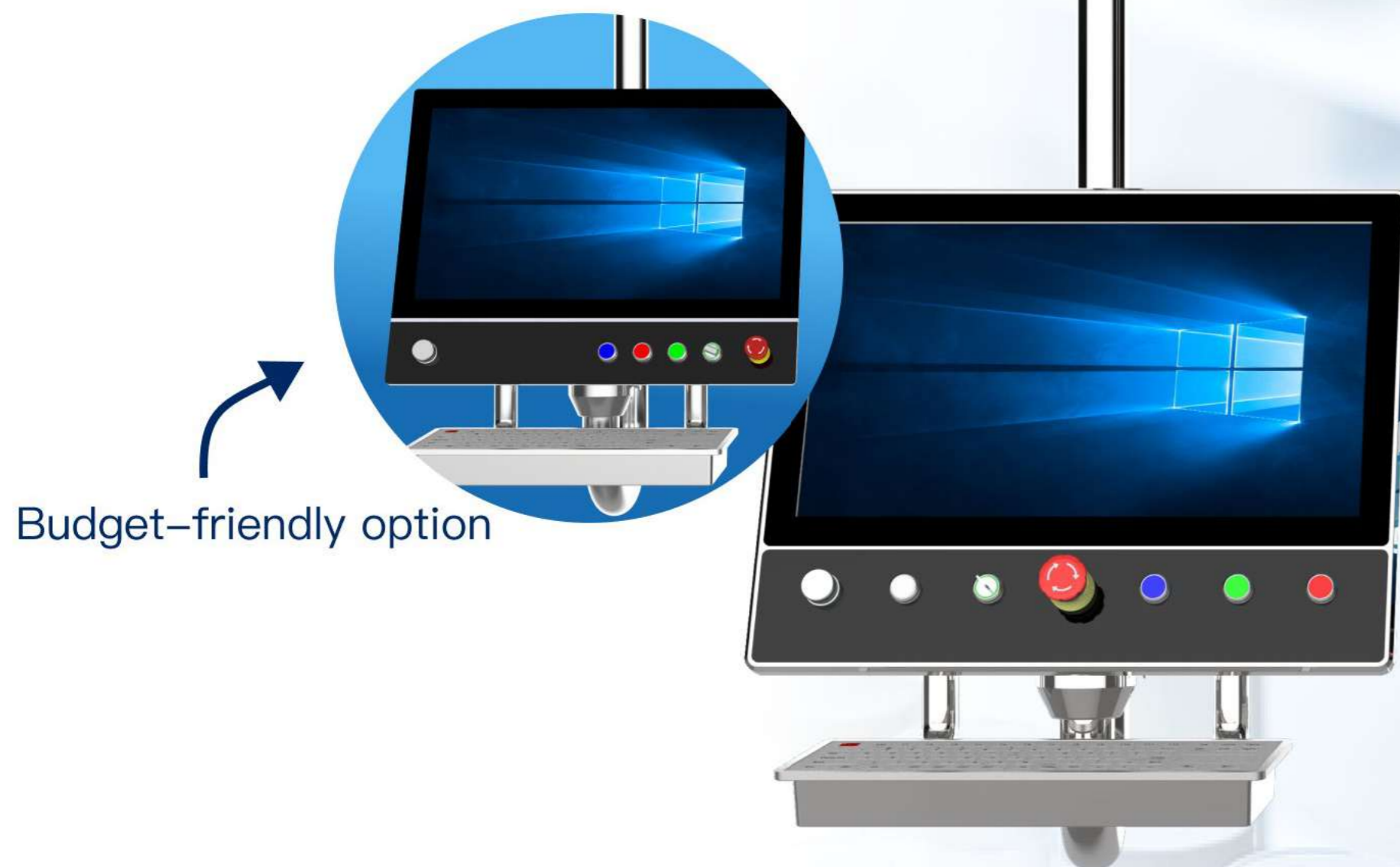

Budget-friendly option

Arm-Mounted Stainless Steel ATEX Industrial HMI



- **The Best Solution For Explosion-Proof Environments**

Passed The ATEX-Ex Protection Certificate

- **Stainless Steel Rounded Flat Panel Design**

Front: 304 Stainless Steel, Easy To Clean And Maintain

- **Meet Strict Hygiene Requirements**

Ideal For Food, Packaging And Pharmaceutical Applications

- **Multiple Operating System**

Windows7, Window8, Windows10, Windows11, Linux, etc

Industrial Monitor

21.5" Size

1920 x 1080

Industrial Panel PC

Intel® Celeron® J6412

Intel® Core™ 6/7/10/11/12/13th i3 i5 i7

New Product

Remote IO

- **High-Performance mini PLC**

Domestic OS Mini PLC With High-Perf MCU

- **Customization Of Local I/O Modules**

Flexible Bus I/O Solutions For Complex Industrial Settings

- **Rich Protocols**

Supports Modbus, CANopen, And EtherCAT

- **Hold In Hand**

Small In Size And Compact In Structure

- **Capacitive Touch**

-10~60°C Working Temperature



Product Overview



Build-in HMI



Arm-mounted HMI



Robot Teach Pendant

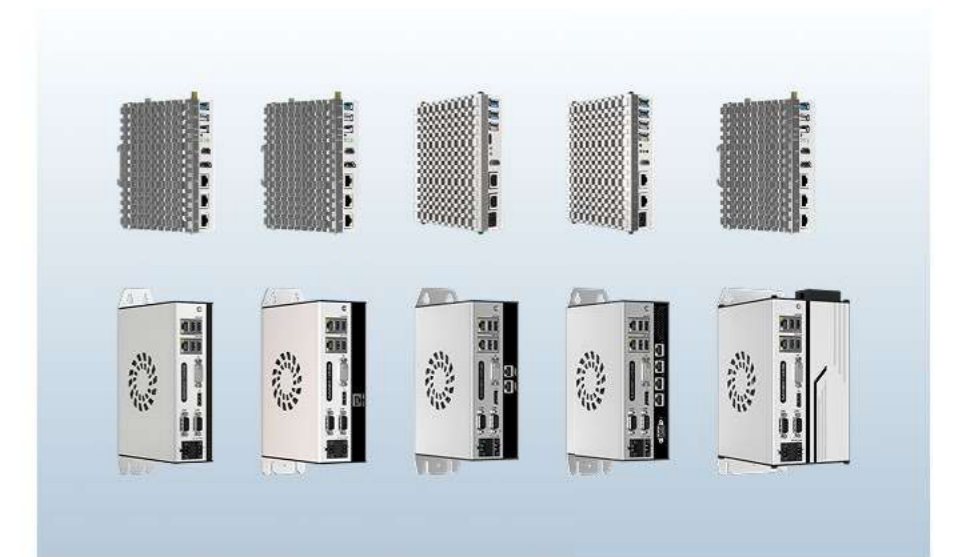

Industrial Automation PC



Hand-held Pendant Station



IDD-LINK4



UPS



Key Control Panel

Build-In HMI

Monitor



Industrial Monitor



Industrial Monitor (With KVM)



Industrial ATEX-EX Monitor

Panel PC



Industrial Panel PC 



Industrial ATEX-EX Panel PC 



Industrial Panel PC (GPIO+WIFI+BT) 



D Series Industrial Panel PC 



ARM Series Industrial Panel PC 



Raspberry Panel PC 

Industrial Monitor

- **Robust Design For Industrialization**

All Aluminum Magnesium Alloy Shell Design, Modular Display

- **Multiple Size Options**

10.1" To 27" , 14 Sizes Available, Include Landscape、Portrait and Wide Screen

- **Front IP65**

Prevent Splashing And Dust In The Working Environment

- **Safety Wide Voltage Power Supply**

DC 12~36V

- **Industry Certified**

CE, FCC And RoHS Certification

- **Multiple Operating System**

Windows7, Window8, Windows10, Windows11, Linux, etc

- **Flexible Installation**

VESA Installation or Embedded Installation

Multiple touch option

① resistance touch ② capacitive touch ③ non-touch



Industrial Monitor (With KVM)

- **Robust Design For Industrialization**
All Aluminum Magnesium Alloy Shell Design, Modular Display
- **Multiple Size Options**
10.1" To 27" , 14 Sizes Available, Include Landscape、Portrait and Wide Screen
- **Front IP65**
Prevent Splashing And Dust In The Working Environment
- **Safety Wide Voltage Power Supply**
DC 12~36V
- **Industry Certified**
CE, FCC And RoHS Certification
- **Multiple Operating System**
Windows7, Window8, Windows10, Windows11, Linux, etc
- **Flexible Installation**
VESA Installation Or Embedded Installation

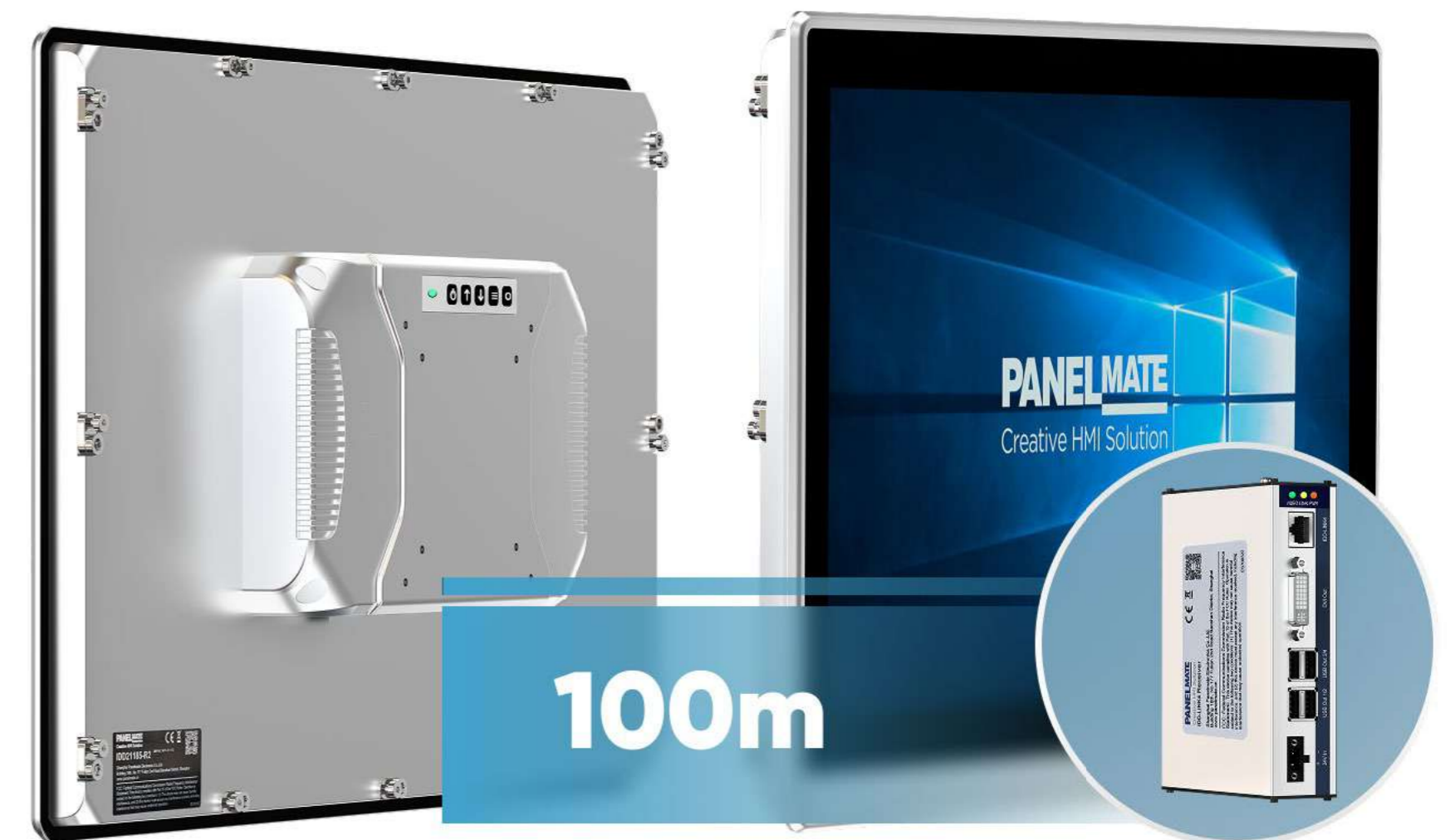

Integrated KVM , Stable Signal Transmission
Transmit Over A Single CAT6 Network Up To 100 Meters

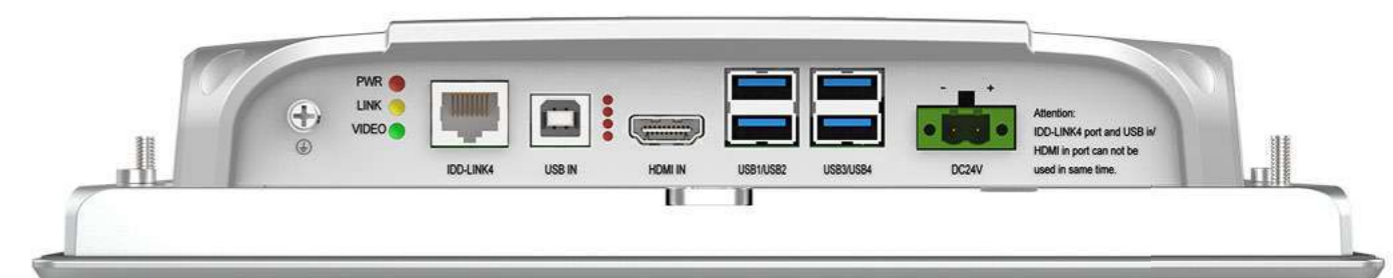

The Best Industrial Display Solution

Applicable Industries Include Factory Automation, Intelligent Transportation, Packaging Industry, Laser Industry, Medical Equipment, Logistics Industry, Etc.



Industrial ATEX Panel

- **The Best Solution For Explosion-Proof Environments**
Aluminum-Magnesium Alloy And Passed The ATEX-Ex Protection Certificate
- **Multiple Size Options**
6 Sizes Include Landscape, Portrait and Wide Screen
- **Front Panel/Rear IP65**
Explosive And Other Harsh Hazardous Environment
- **Industry Certified**
CE, FCC And RoHS Certification
- **Excellent Touch Experience**
Multi-Point Capacitive Touch For Easy Touch In Harsh Environments
- **Multiple Operating System**
Windows7, Window8, Windows10, Windows11, Linux, etc



Integrated KVM , Stable Signal Transmission
Transmit Over A Single CAT6 Network Up To 100 Meters

Flexible Deployment

Our Explosion-Proof Products Have Passed ATEX EU Explosion-Proof Certification



Applicable Industry

Petroleum Industry, Chemical Industry, Military Field, Mining Industry, Etc.

Industrial Panel PC

PANELMATE
Creative HMI Solution

- **Robust Design For Industrialization**

All Aluminum Magnesium Alloy, Rear Hood Aluminum Fin Heat Dissipation Design

- **Multiple Size Options**

10.1" To 27" , 14 Sizes Available, Include Landscape、Portrait and Wide Screen

- **Front IP65**

Prevent Splashing And Dust In The Working Environment

- **Real-Time Data Exchange**

Expandable WIFI, 4G Network

- **Industry Certified**

CE, FCC And RoHS Certification



- **Multiple Operating System**

Windows7, Window8, Windows10, Windows11, Linux, etc

- **Flexible Installation**

VESA Installation Or Embedded Installation

- **Multiple Touch Option**

① Resistance Touch ② Capacitive Touch ③ Non-Touch

- **Storage And HDD**

RAM: DDR4 Max 64GB

SSD : 64GB~1T

- **Superior Performance Supported By Intel®**

Intel® Celeron® J6412

Intel® Core™ 6/7/10/11/12/13th i3 i5 i7

Intel® Processor N97



Industrial ATEX Panel PC

PANELMATE
Creative HMI Solution

- **The Best Solution For Explosion-Proof Environments**

Aluminum-Magnesium Alloy And Passed The ATEX-Ex Protection Certificate

- **Multiple Size Options**

6 Sizes Include Landscape、Portrait and Wide Screen

- **Front Panel/Rear IP65**

Explosive And Other Harsh Hazardous Environment

- **Real-Time Data Exchange**

Expandable WIFI, 4G Network

- **Industry Certified**

CE, FCC And RoHS Certification

- **Multiple Operating System**

Win7, Win8, Win10, Win11, Linux, etc

- **Excellent Touch Experience**

Multi-Point Capacitive Touch For Easy Touch In Harsh Environments

- **Storage And HDD**

RAM: DDR4 Max 32GB

SSD : 64GB~1T

- **Superior Performance Supported By Intel®**

Intel® Celeron® 3855U/3865U

Intel® Core™ 6/7th i3 i5 i7



*product parameter please contact sales or engineers to obtain product datasheet

Industrial Panel PC (GPIO+WIFI+BT)

PANELMATE
Creative HMI Solution

- **Robust Design For Industrialization**

All Aluminum Magnesium Alloy, Rear Hood Aluminum Fin Heat Dissipation Design

- **Multiple Size Options**

10.1" To 27" , 14 Sizes Available, Include Landscape、Portrait and Wide Screen

- **Front IP65**

Prevent Splashing And Dust In The Working Environment

- **Real-Time Data Exchange**

Expandable WIFI, 4G Network

- **Industry Certified**

CE, FCC And RoHS Certification



- **Multiple Operating System**

Windows10, Windows11, Linux, etc

- **Flexible Installation**

VESA Installation Or Embedded Installation

- **Multiple Touch Option**

① Resistance Touch ② Capacitive Touch ③ Non-Touch

- **Compatibility And Versatility**

Expanded GPIO And Wifi Antenna

- **Superior Performance Supported By Intel®**

Intel® Celeron® J6412

Intel® Core™ 11th i3 i5 i7



D Series Industrial Panel PC

PANELMATE
Creative HMI Solution

- **Robust Design For Industrialization**

All Aluminum Magnesium Alloy, With PC6970 Series Desktop Host

- **Multiple Size Options**

12.1" To 27" , 12 Sizes Available, Include Landscape、Portrait and Wide Screen

- **Front IP65**

Prevent Splashing And Dust In The Working Environment

- **Real-Time Data Exchange**

Expandable WIFI, 4G Network

- **Industry Certified**

CE, FCC And RoHS Certification



- **Multiple Operating System**

Win7, Win8, Win10, Win11, Linux,etc

- **Modular Support Extension**

Expansion 1 X PCIe X 16 + 1 X PCIe X 8 Or 1 X PCIe X 16 + 1 X PCI

- **Multiple Touch Option**

① Resistance Touch ② Capacitive Touch ③ Non-Touch

- **Compatibility And Versatility**

Expanded GPIO And Wifi Antenna

- **Superior Performance Supported By Intel®**

Intel® Celeron® 4400

Intel® Core™ 6/7/8/9th i3 i5 i7



PANELMATE
Creative HMI Solution

Applicable Industry

Power Industry, Intelligent Manufacturing,
Robot Control, Pharmaceutical Industry, Logistics Industry, etc.



intel® core™ 6/7th series embedded industrial monitor



Provides High Performance And Low Power Consumption

Meet The Needs Of Industrial And Rugged Applications

*The interface of each model is inconsistent, please refer to the specification for datasheet

ARM Series Industrial Panel PC

PANELMATE
Creative HMI Solution

- **Robust Design For Industrialization**

All Aluminum Magnesium Alloy, With PC6970 Series Desktop Host

- **Multiple Size Options**

10.1" To 27" , 14 Sizes Available, Include Landscape、Portrait and Wide Screen

- **Front IP65**

Prevent Splashing And Dust In The Working Environment

- **Real-Time Data Exchange**

Expandable WIFI, 4G, 5G Network

- **Industry Certified**

CE, FCC And RoHS Certification



- **Multiple Operating System**

Android 11, Ubuntu 20.04

- **Multiple Touch Option**

① Resistance Touch ② Capacitive Touch ③ Non-Touch

- **Compatibility And Versatility**

Built In miniPCle Slot And Wifi Antenna

- **Safety Wide Voltage Power Supply**

DC 12~36V

- **China Self-Developed ARM Architecture CPU**

Rockchip RK3568



Raspberry Panel PC

- **Robust Design For Industrialization**

All Aluminum Magnesium Alloy Shell Design, Modular Display

- **Multiple Size Options**

10.1" To 27" , 14 Sizes Available, Include Landscape、Portrait and Wide Screen

- **Front IP65**

Prevent Splashing And Dust In The Working Environment

- **Safe Power Failure Protection**

Built-In UPS Power Supply

- **Industry Certified**

CE, FCC And RoHS Certification

- **Flexible Installation**

VESA Installation Or Embedded Installation

- **Multiple Touch Option**

① Resistance Touch ② Capacitive Touch ③ Non-Touch



Arm-mounted Operation HMI

Operation Panel



Economic Industrial Arm-Mounted Operation Panel



Industrial Arm-Mounted Operation Panel



Industrial Arm-Mounted Operation Panel (With KVM)

Panel PC



Industrial Arm-Mounted Operation Panel PC 

Applicable Industry

Intelligent Manufacturing, Laser Industry, Pharmaceutical Industry, Packaging Industry, Logistics Industry, Etc.

Economic Industrial Arm-Mounted Operation Panel

- **Industrial Grade Economic Type Design**
All Aluminum Housing Design
- **FHD High Resolution Screen**
21.5" FHD High-Resolution Screen, Dpi 1920x1080
- **Front IP65**
Prevent Splashing And Dust In The Working Environment
- **0-320° Rotatable System**
Connectors Supporting Various Arm-Mounted Profiles
- **Industry Certified**
CE, FCC And RoHS Certification
- **Multiple Operating System**
Win7, Win8, Win10, Win11, Linux,etc
- **Excellent Operation With Indicator Keys**
Logo / Text / Color Of Key Membrane Can Be Customized
- **Multiple Touch Option**
① Resistance Touch ② Capacitive Touch ③ Non-Touch



Industrial Arm–Mounted Operation Panel

- **Robust Design For Industrialization**
All Aluminum Magnesium Alloy Shell Design, Modular Display
- **Multiple Size Options**
15" To 21.5", 5 Sizes Include Landscape, Portrait and Wide Screen
- **Front Panel/Rear IP65**
Prevent Splashing And Dust In The Working Environment
- **0–320° Rotatable System**
Connectors Supporting Various Arm–Mounted Profiles
- **Industry Certified**
CE, FCC And RoHS Certification
- **Safety Wide Voltage Power Supply**
DC 12~36V
- **Flexible Expansion From Multiple Angles**
Tilt Angle, Lower Support, Upper Round Pipe/Square Pipe Installation



- **Multiple Operating System**
Windows7, Window8, Windows10, Windows11, Linux, etc
- **Excellent Operation With Indicator Keys**
Logo / Text / Color Of Key Membrane Can Be Customized
- **Multiple Touch Option**
① Resistance Touch ② Capacitive Touch ③ Non–Touch

100m



Industrial Arm Mounted Operation Panel (KVM Extender)

Designed For Large Industrial Equipment Integrated KVM Function, Stable Signal Transmission

Dual-Screen Industrial Arm-Mounted Operation Panel

- **Robust Design For Industrialization**

All Aluminum Magnesium Alloy Shell Design, Modular Display

- **Double Screen , Double Efficiency**

Dual 21.5" Display Size

- **Front Panel/Rear IP65**

Prevent Splashing And Dust In The Working Environment

- **0-320° Rotatable System**

Connectors Supporting Various Arm-Mounted Profiles

- **Industry Certified**

CE, FCC And RoHS Certification

- **Safety Wide Voltage Power Supply**

DC 12~36V

- **Multiple Touch Option**

① Resistance Touch ② Capacitive Touch ③ Non-Touch



Industrial Arm-Mounted Operation Panel PC

- **Robust Design For Industrialization**
All Aluminum Magnesium Alloy, Rear Hood Aluminum Fin Heat Dissipation Design
- **Multiple Size Options**
15" To 27", 7 Sizes Include Landscape, Portrait and Wide Screen
- **Front Panel/Rear IP65**
Prevent Splashing And Dust In The Working Environment
- **0-320° Rotatable System**
Connectors Supporting Various Arm-Mounted Profiles
- **Industry Certified**
CE, FCC And RoHS Certification
- **Real-Time Data Exchange**
Expandable WIFI, 4G Network
- **Flexible Expansion From Multiple Angles**
Tilt Angle, Lower Support, Upper Round Pipe/Square Pipe Installation



- **Multiple Operating System**
Windows7, Windows8, Windows10, Windows11, Linux, etc
- **Excellent Operation With Indicator Keys**
Logo / Text / Color Of Key Membrane Can Be Customized
- **Multiple Touch Option**
① Resistance Touch ② Capacitive Touch ③ Non-Touch

Industrial Arm-Mounted Operation Panel PC

- **Storage And HDD**

RAM: DDR4 Max 32GB

SSD : 64GB~1T

- **Superior Performance Supported By Intel®**

Intel® Celeron® J6412

Intel® Core™ 6/7/11th i3 i5 i7



right view



side view



rear view



front view

Stainless Steel Series

High-Quality HMI Solutions
For The Life Sciences Industry



Clean

Clean & Corrosion Resistant



HMI

Meets Application And Budget

PANELMATE
Creative HMI Solution

Stainless Steel Series Monitor



Industrial Stainless Steel Monitor



Industrial Arm-mounted Stainless Steel Monitor

Optional R2 (IDD-LINK4)

Industrial Stainless Steel Monitor

New

- **Stainless Steel Rounded Flat Panel Design**
Front: 304 Stainless Steel, Easy To Clean And Maintain
- **Meet Strict Hygiene Requirements**
Ideal For Food, Packaging And Pharmaceutical Applications
- **Take Your Pick**
Display Size: 15.6", 21.5"; 15.6" Support FHD
- **Front Panel IP65**
Prevent Splashing And Dust In The Working Environment
- **Better Control Panel**
With Control Panel, Quick And Easy To Operate
- **Multiple Operating System**
Windows7, Window8, Windows10, Windows11, Linux, etc
- **Touch Option**
 - ① Capacitive Touch
 - ② Non-Touch



15.6" built-in stainless steel monitor

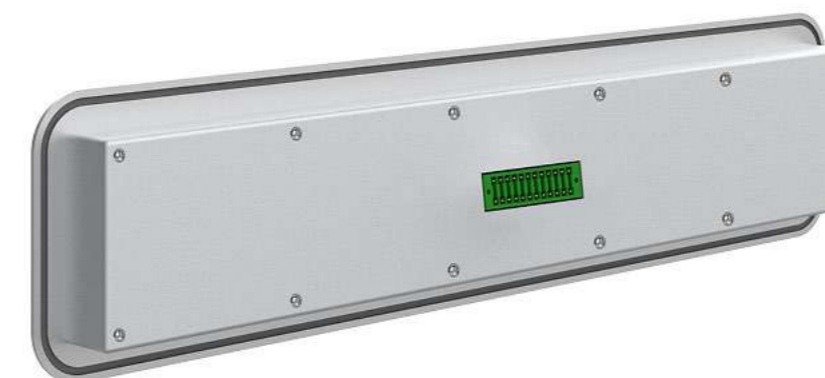

Stainless steel control panel

Industrial Arm-mounted Stainless Steel Monitor **New**

- **Stainless Steel Rounded Flat Panel Design**
Front: 304 Stainless Steel, Easy To Clean And Maintain
- **Meet Strict Hygiene Requirements**
Ideal For Food, Packaging And Pharmaceutical Applications
- **Take Your Pick**
Display Size: 15.6", 21.5"; 15.6" Support FHD
- **Front Panel/Rear IP65**
Prevent Splashing And Dust In The Working Environment
- **Better Control Panel**
With Control Panel, Quick And Easy To Operate
- **Multiple Operating System**
Windows7, Window8, Windows10, Windows11, Linux, etc
- **Touch Option**
① Capacitive Touch ② Non-Touch
- **Modular Design And Easy Installation**
Integrated Custom VESA Bracket Installation



Do More. Effort Less.

Teach Pendant For Handling Robots



PANELMATE
Creative HMI Solution

Teach Pendant **New**

- **Lightweight And Flexible Deployment**
10.1" Monitor, 1280x800
- **Human-Computer Experience**
Two-Handed Operation, Shoulder Straps & Handles Relieve Fatigue
- **Quick Button Integration**
Lower Right Button Corner Allows Quick Access To Custom Functions
- **Absolutely Safe Design**
System Frame Ground Protection (GPE) Design
- **Multiple Operating System**
Windows7, Window8, Windows10, Windows11, Linux, etc
- **Multiple Touch Option**
 - ① Resistance Touch ② Capacitive Touch
(A Capacitive Stylus At The Back)



PANELMATE

Creative HMI Solution



*product parameter please contact sales or engineers to obtain product datasheet

PC69XX Series Wall-mounted Box PC

PC6970 Series *High Performance Desktop CPU*

Intel® Core™ 6/7/8/9th i3/i5/i7、Intel® Pentium® G4400

PC6920 Series *Low Power Consumption*

Intel® Core™ 10/11/12/13th i3/i5/i7、Intel® Celeron® J6412



- Compacted Aluminium–Magnesium Alloy Profile Housing
- Unilateral Interface, DIN Rail Wall–Mounted
- DVI+DP Dual Interface
- BIOS COM Port Setting RS232 Or RS485

- OS:Win7, Win8, Win10, Win11, Linux ,Etc
- Real–Time Motion Control
- USB2.0 Dongle Port Prevents Data Loss.
- DC 12~36V

Flexible Expansion, Comprehensive Use Of Demand Solutions



PC69XX

- 2 x RJ45
- 2 x RS232 (Can Set RS485)
- 4 x USB3.0 + Built-In 1 x USB2.0



PC69XX-4RJ

- 4 x RJ45
- 2 X RS232 (Can Set RS485)
- 4 X USB3.0 + Built-In 1 X USB2.0



PC69XX-POE

- 2 x RJ45
- 2 X RS232 (Can Set RS485)
- 4 X USB3.0 + Built-In 1 X USB2.0
- 4 x POE
- 16 pin DIO
- 1 x MIO



PC69XX-PCI

- 2 x RJ45
- 2 X RS232 (Can Set RS485)
- 4 X USB3.0 + Built-In 1 X USB2.0
- 1 x PCIe1
- 1 x PCI



PC69XX-PCIe

- 2 x RJ45
- 2 X RS232 (Can Set RS485)
- 4 X USB3.0 + Built-In 1 X USB2.0
- 2 x PCIe1

PC60XX Series mini BOX Fanless iBOX PC

- Compact Al-Mg Housing; Large Al Fins For Cooling
- Unilateral Interface, Flat Or Wall Mounted
- Expandable WIFI, 4G Network
- Fanless, Operating Temperature Range-20~70°C
- DC 9~36V



PC6010

Intel® Celeron® J1900

PC6008 NEW

Rockchip RK3568

PC6017 NEW

Intel® Processor N97

PC6012

Intel® Celeron® J6412

PC6005 NEW

Raspberry PI CM5



android 

ubuntu 

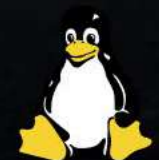

Flexible Expansion, Comprehensive Use Of Demand Solutions

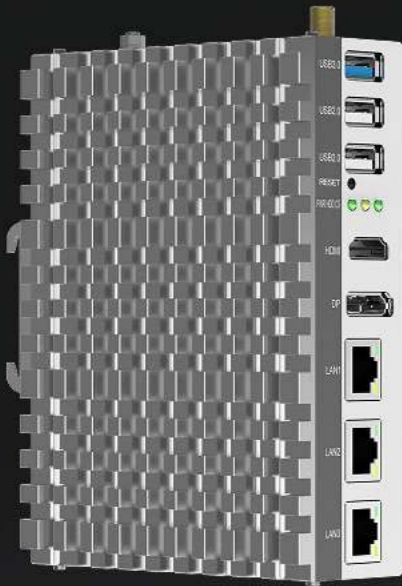

PC6010
Intel® Celeron® J1900
3 x RJ45
1 x DP + 1 x HDMI
3 x USB

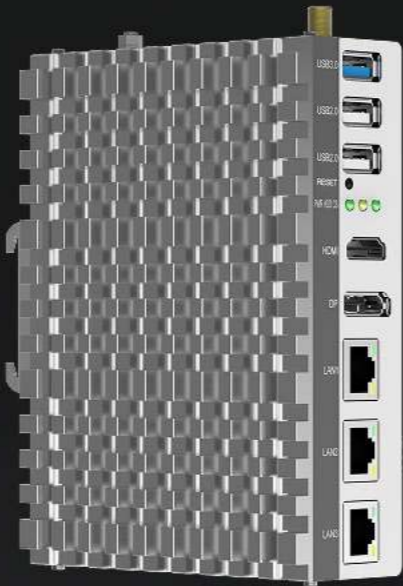

PC6012
Intel® Celeron® J6412
3 x RJ45
1 x DP + 1 x HDMI
3 x USB



PC6008 **NEW**
Rockchip RK3568
2 x RJ45(EtherCAT)
1 x HDMI
3 x USB



PC6005 **NEW**
Raspberry PI CM5
2 x RJ45
1 x HDMI
4 x USB

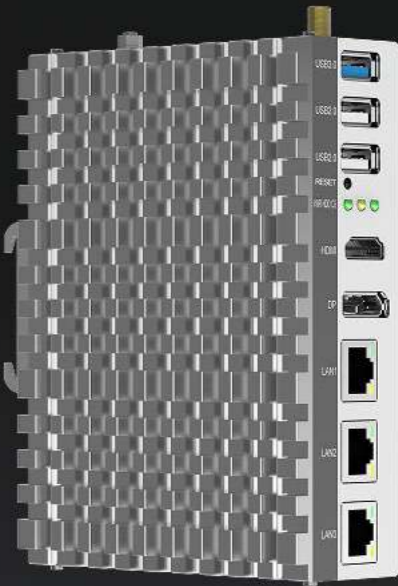

PC6017 **NEW**
Intel® Processor N97
3 x RJ45
1 x DP + 1 x HDMI
3 x USB

iBOX22XX Fanless iBOX PC

- Compact Al-Mg Housing & Large Rear Aluminum Fins For Superior Cooling.
- Unilateral Interface, Flat Or Wall Mounted
- 2 X COM (DB9) , Support BIOS To Select RS232 Or RS485
- Intel® Celeron® 3855U, Intel® Celeron® J6412、
Intel® Core™ 6/7/10/11/12/13th I3/I5/I7 Series To Optional
- Expandable WIFI, 4G ,5G Network
- Fanless, Operating Temperature Range-20~70°C
- DC 9~36V



Hand-Held Pendant Station

- Support EtherCAT, Modbus-TCP, ADS, Etc.
- ABS Lightweight Material, Thin Type and Durable
- IP50, CE Compliance
- Wireless HPS Can Be Rechargeable With Lithium Battery
- Wired HPS With DC 24V Power Supply
- Work Temperature $-20\sim 70^{\circ}\text{C}$
- Include 1 Enable Key, 1 NO Contact, And 2 Modes
- Magnetic Installation And Bracket Installation In 2 Ways

Membrane Key Form Customization
Wireless Wired Mode Is Optional



HPS11E
Push-Button
Wired Handheld Unit



HPS21E
Push-Button
Wireless Handheld Unit



HPS31E
MPG Type
Wired Handheld Unit



HPS51 (E)
MPG Type
Wired Handheld Unit

Fast Response, Reliable Signal Output

Core Components Of Automatic Equipment



Key Control Panel



- Panel:Aluminium–Magnesium Alloy,Rear:Stainless Steel
- Front Panel/Rear: IP65 / IP20
- Support EtherCAT And Modbus–TCP Protocol
- Support 98 Keys And 98 LED, No Need Any I/O Modules
- Equipped With Time Control Function
- DC 24V
- Lockable Key For Easy Keyboard Cleaning
- Can Be Customized According To Customer Requirements, Including
The Number Of Keys, Labels, And Bus Protocols

Multi-Control Integration Customization
No Wiring, Out Of The Box
Effectively Reduce The Failure Rate

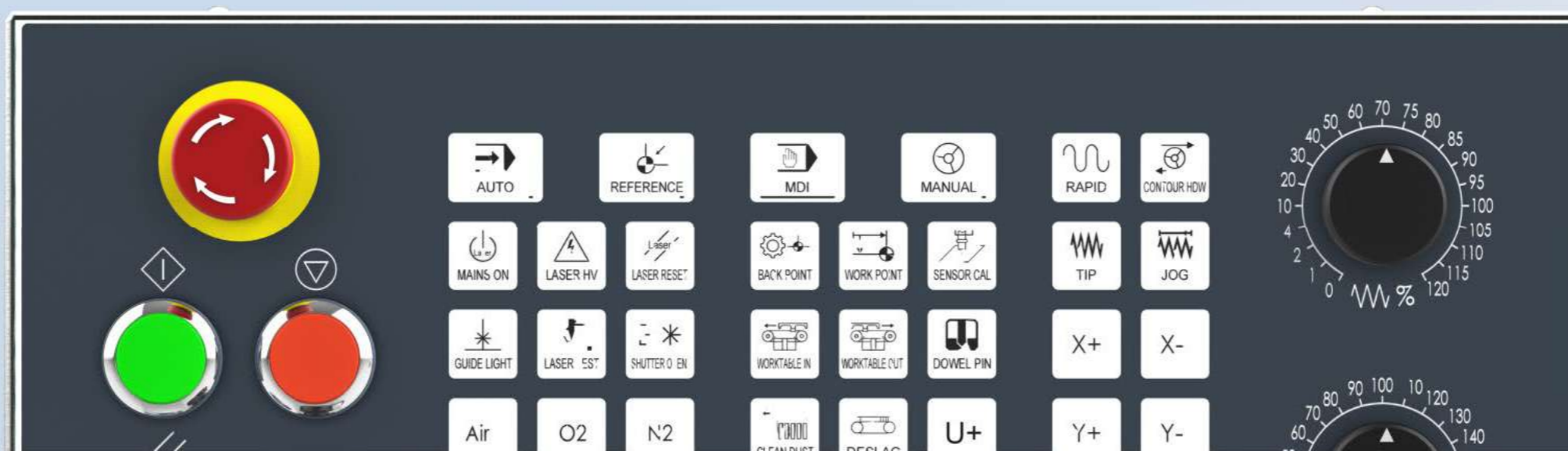
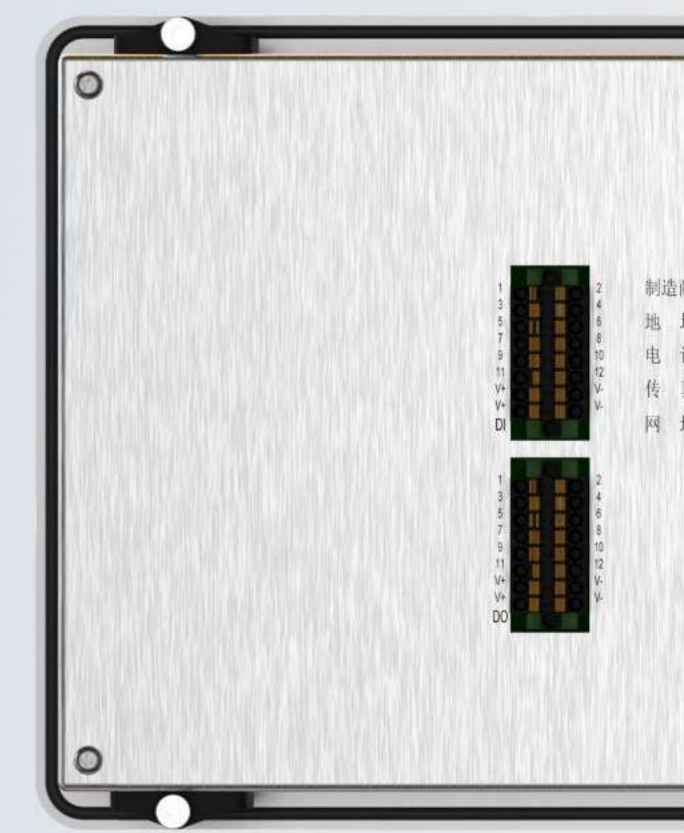
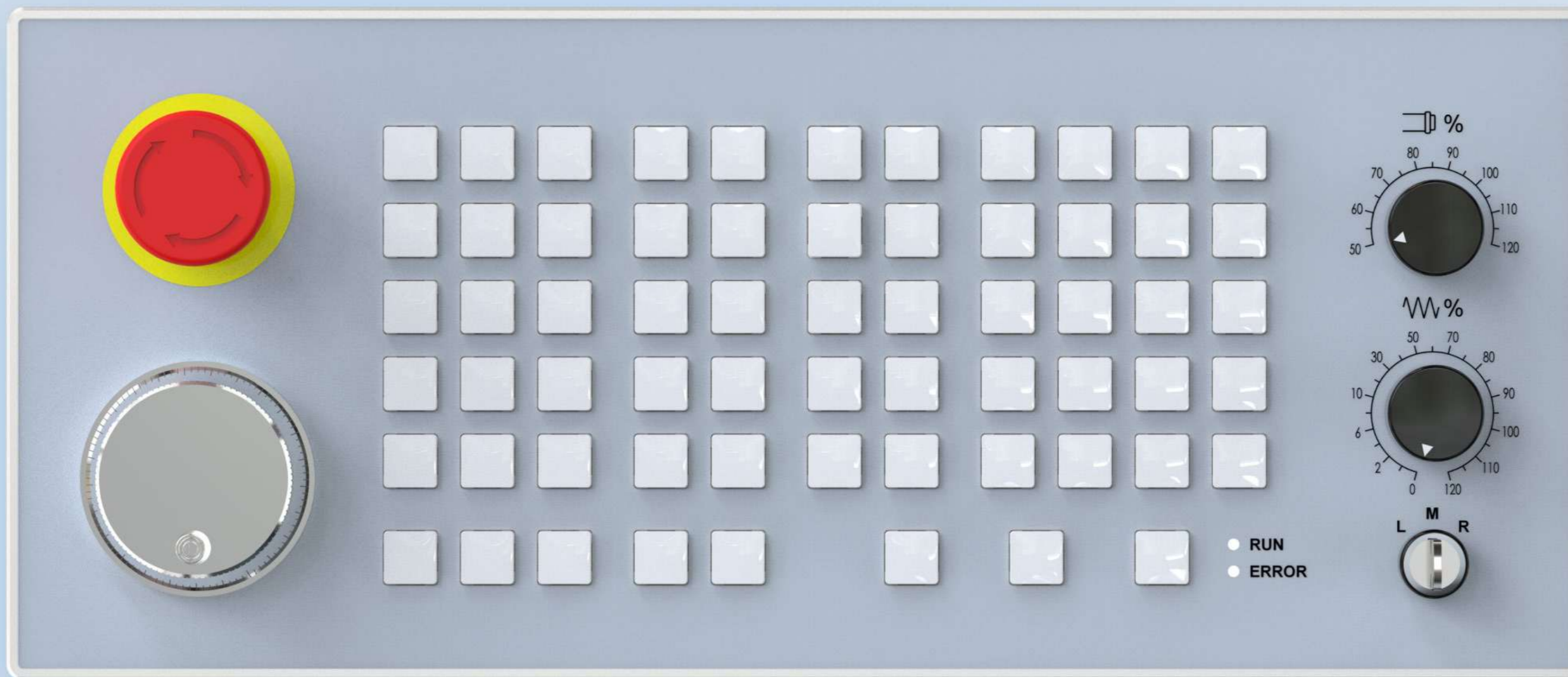
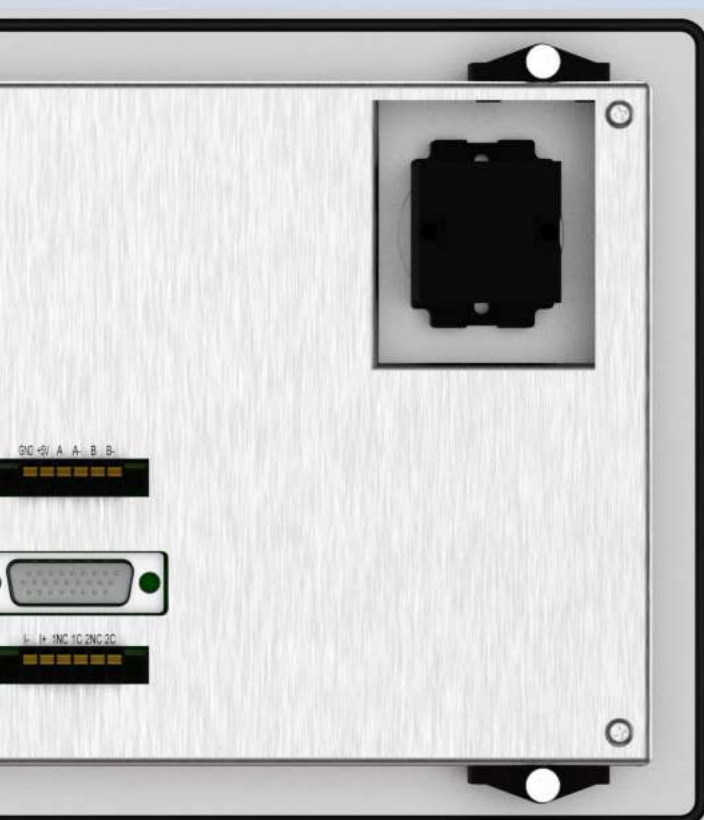

KVM Extender

- Compacted Aluminium–Magnesium Alloy Profile House, Sealed And Dust–Proof Design
- Unilateral Interface With DIN Rail Wall–Mounted
- DC 24V Power Supply, Industrial Standard Design
- Compatible With Beckhoff CP–LINK4, Siemens IFP V2 And B&R SDL4
- Integrated Into PC6960 Box PC
- Integrated With All Industrial Displays Of Model IDDXXXXX Series



IDD–LINK4–Transmitter



IDD–LINK4–Receiver

100m Equipment Transmission 0 Delay, Stable Signal Transmission 100m

IDD-LINK4 Connection Application

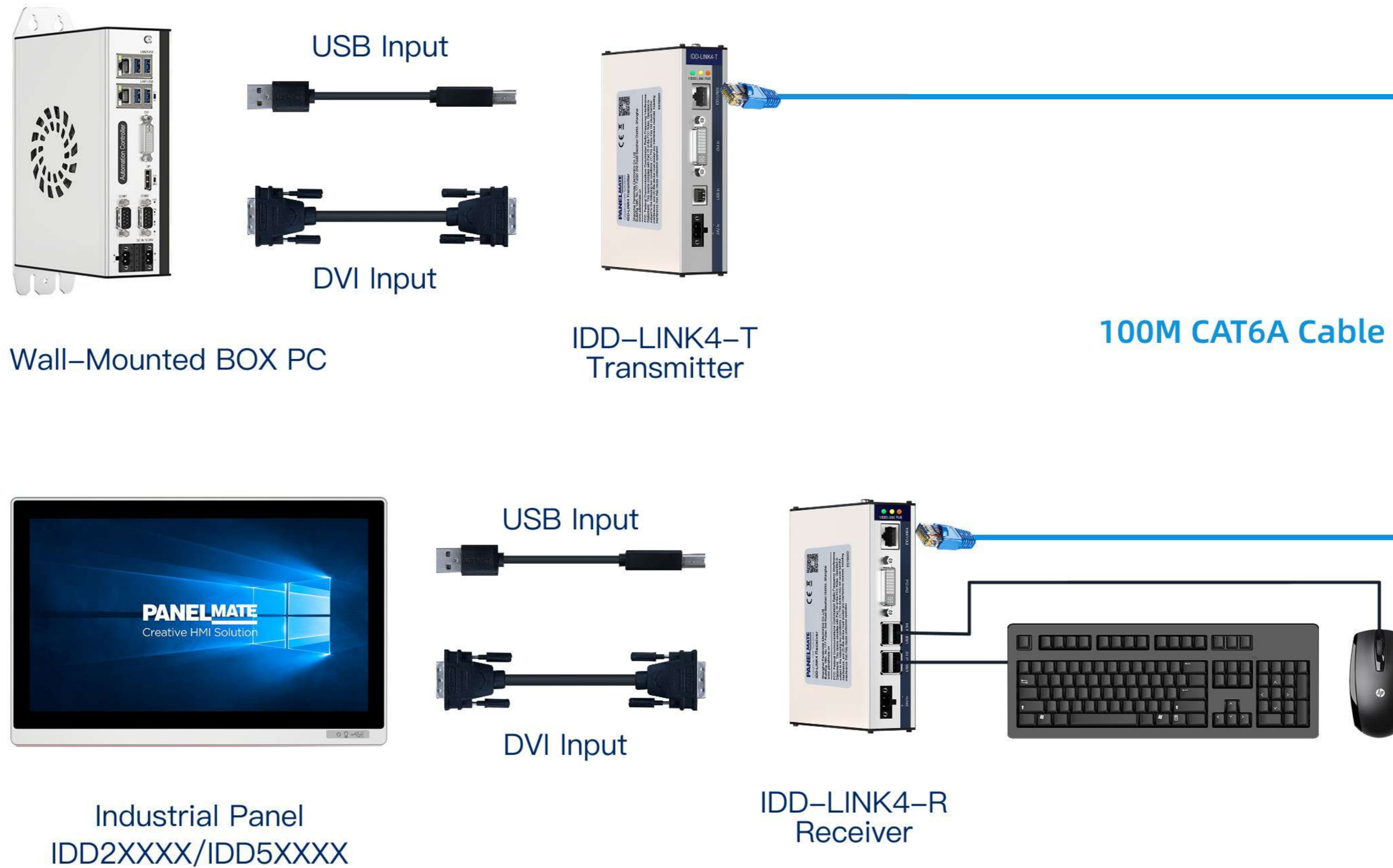



Beyond Standard

Custom OEM / ODM Solutions

End-To-End Industrial Customization

PANELMATE
Creative HMI Solution



Customization

Mechanical Customization
Cosmetic Customization
System Customization



Integration

Full System Integration
OS & Software Pre-Load
Managed Project Delivery



Validation

System Reliability Test
Functional Test
Vibration Test



Certification

Explosion-Proof Certification
Safety Regulatory
EMI/EMC

Recent Design Rendering Preview



Intelligent Equipment



CNC Machine



Automobile Manufacturing Industry

Arm Mounted 15.6" FHD Industrial Monitor

Arm Mounted 21.5" Industrial Panel PC

Arm Mounted 15" Industrial Panel PC



Robot Welding System

Hand-Held Pendant Station



Laser Industry

Build-In 21.5" Industrial Monitor

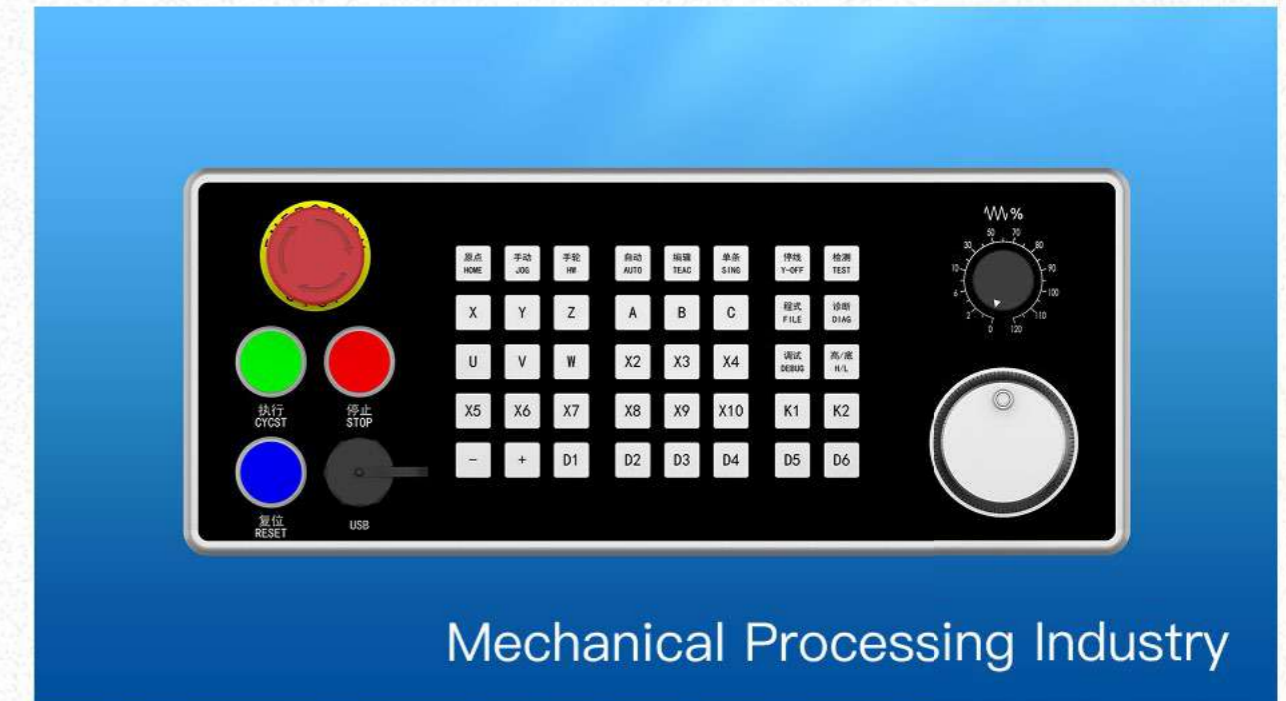

Mechanical Processing Industry

CNC Control Panel

Raspberry Programmable Logic Controller

The Industrial Controller Based On Raspberry Pi Computer Module 5 Provides CodeSys–Based Soft PLC System With Extremely High Cost Performance, Which Is Suitable For Automation Industry, Electronic Power, Smart Home And So On.

- All Aluminium Housing, Excellent EMC Shielding Capability
- Unilateral Interface With DIN Rail Wall–Mounted
- DC 24V
- Support LINUX Or Raspberry Pi OS
- Wide Working Temperature: $-20^{\circ}\text{C}\sim 60^{\circ}\text{C}$
- BMS System, 30S Shutdown Time Is Provided By Default
- Support SoftMotion、Visualization (Chromium WebVisu)
- Support Trace、Breakpoints、Flow Control Debug



-  RTC Real-Time Clock
-  Multiple Connections, Multiple Choices
-  Built-In UPS Uninterruptible Power Supply
-  Highly Reliable And Diverse Network

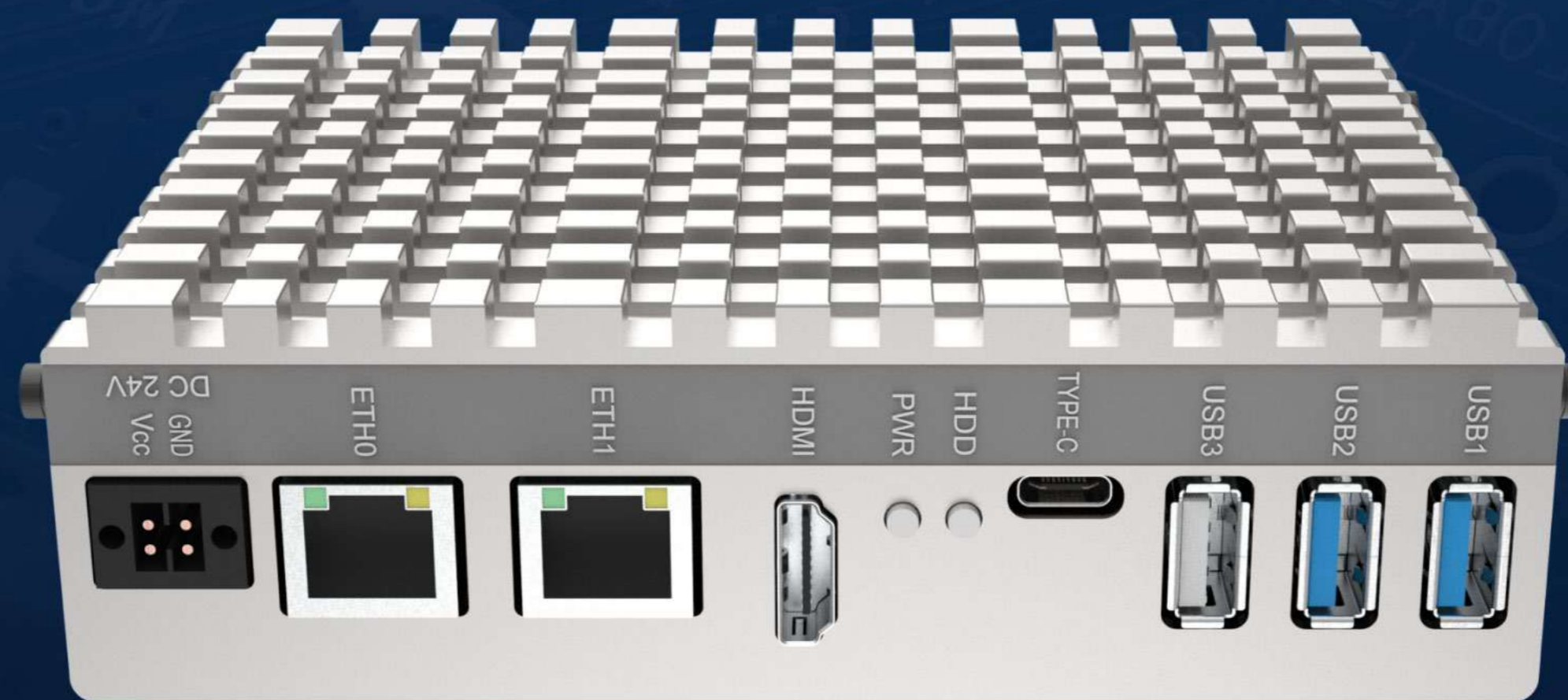

02 PanelMate Projects

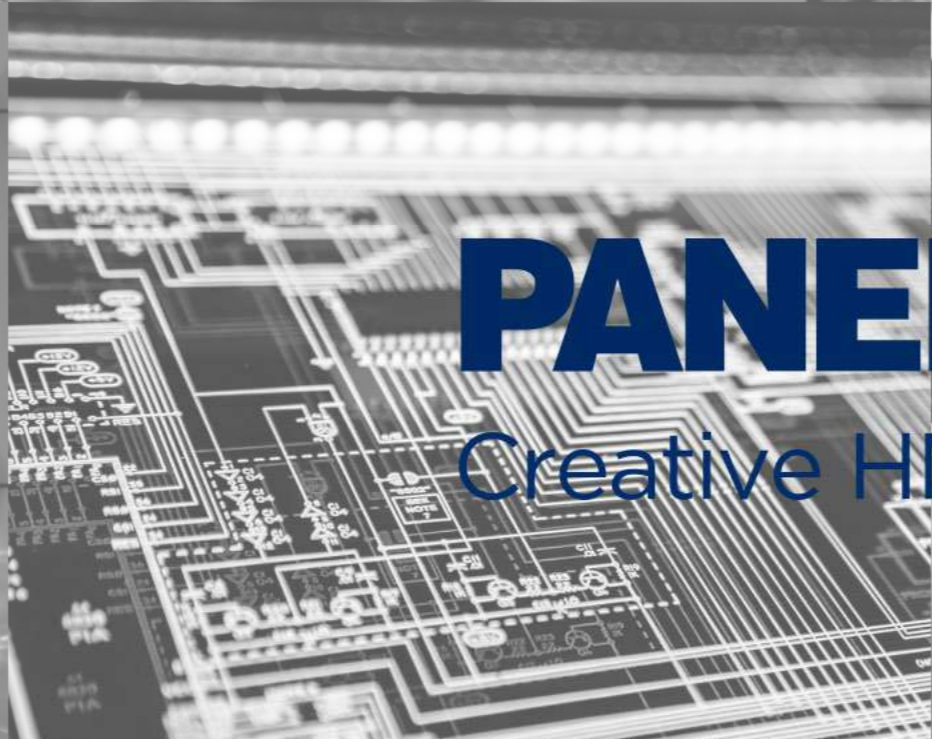

PANELMATE
Creative HMI Solution

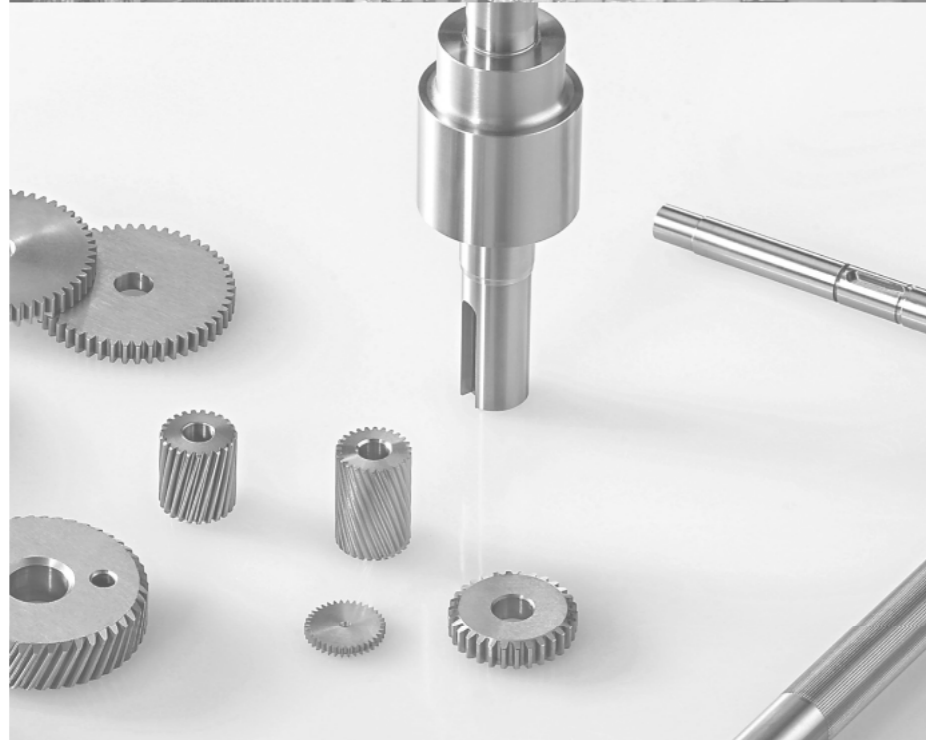

Photovoltaic Industry

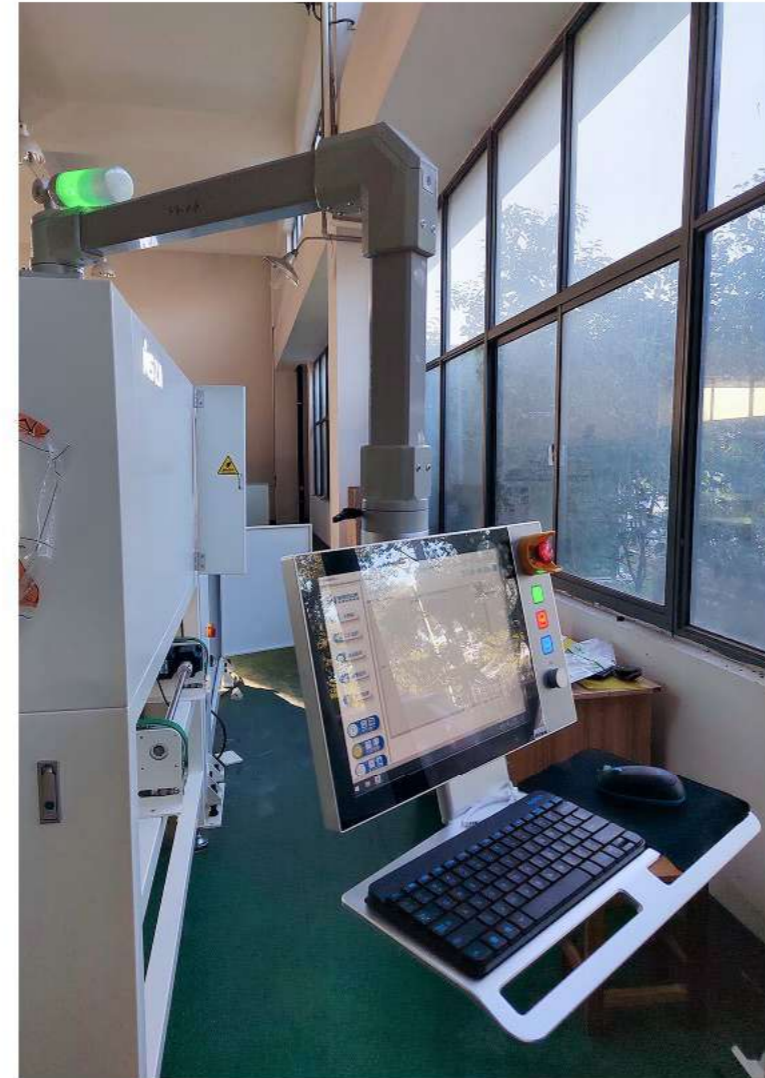

Laser Industry



Woodworking



Plastic Machine Industry



Printing Industry



Automation Industry

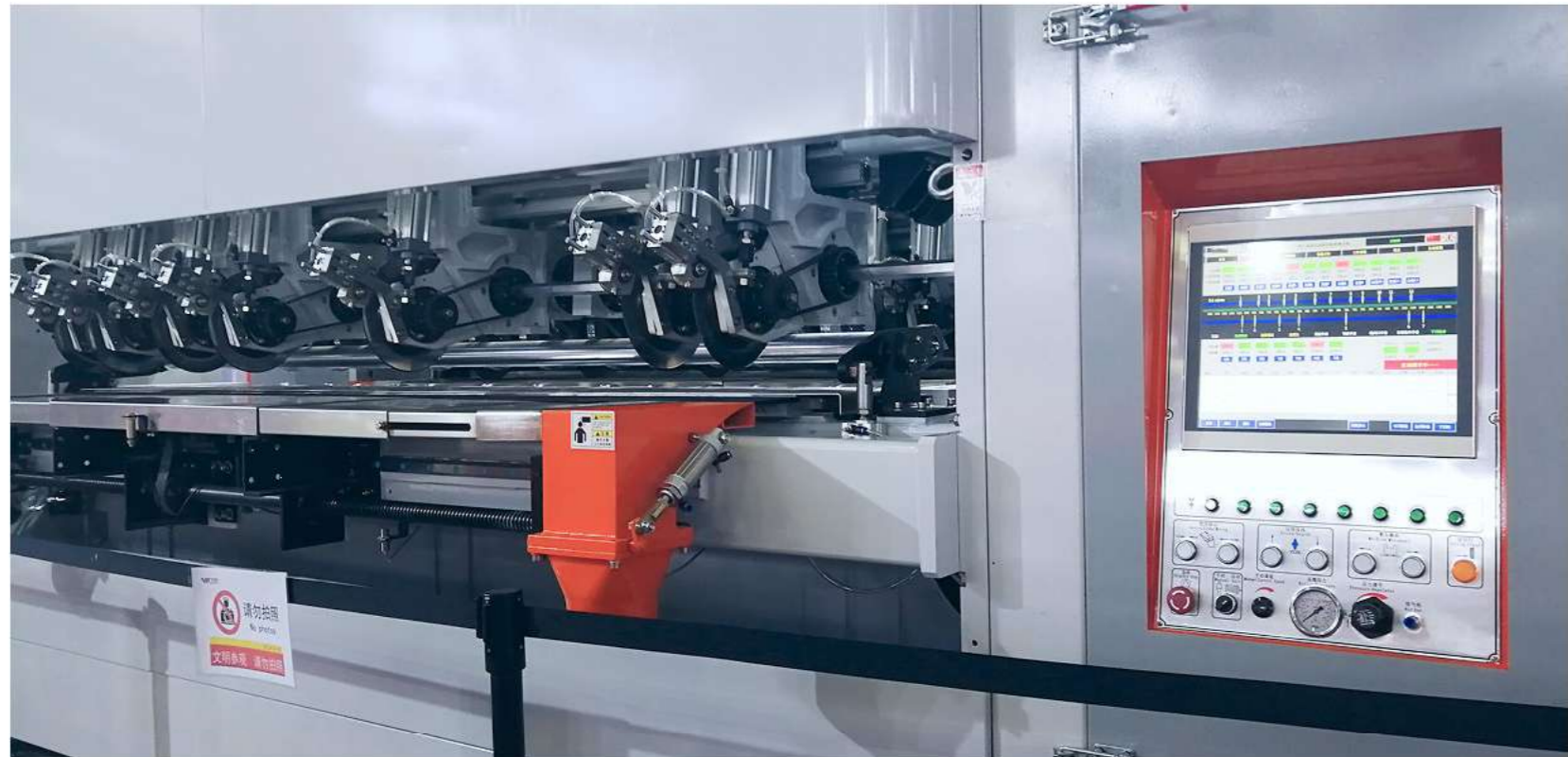

Medical Industry



CNC Machine Tool

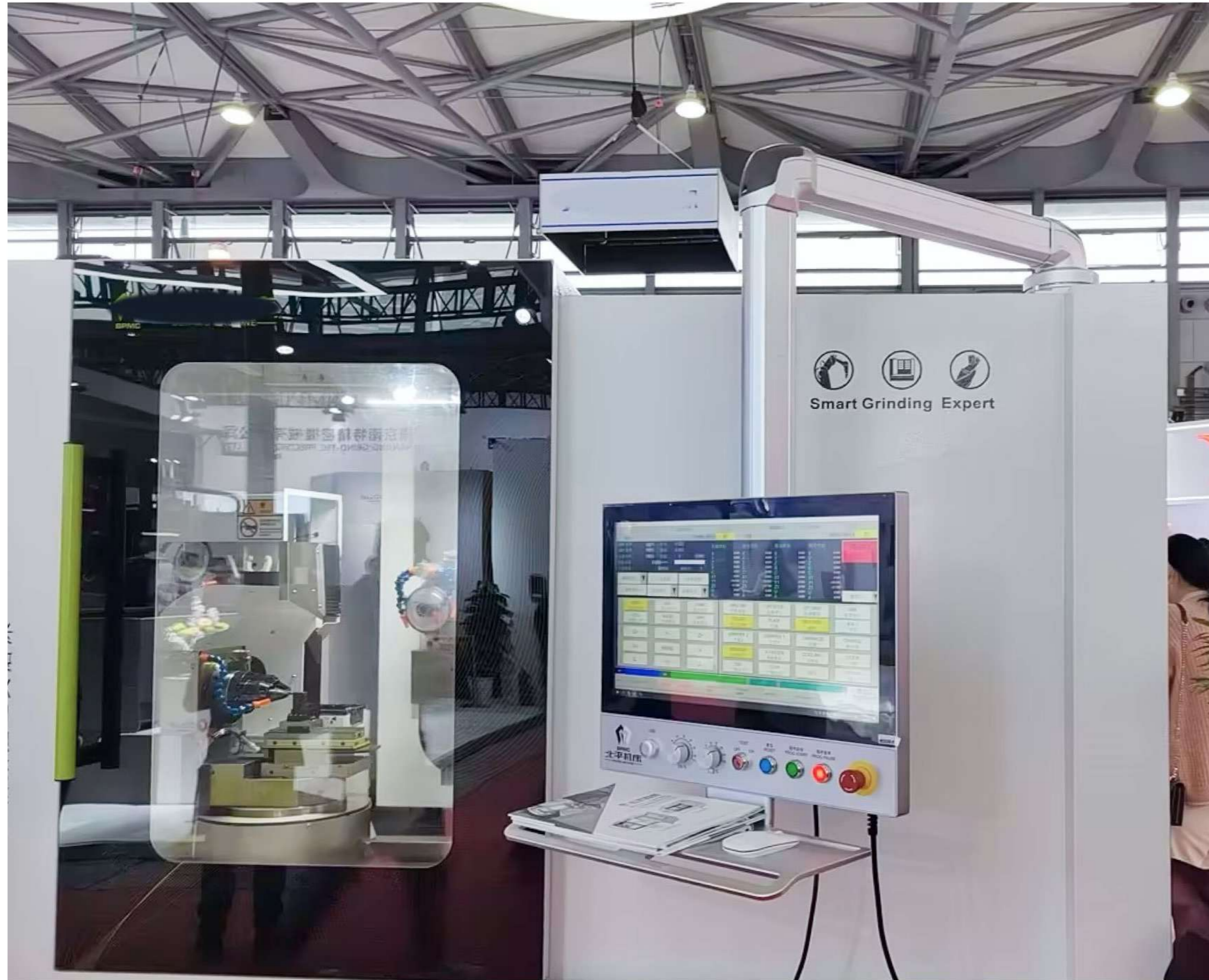

03 PanelMate Value And Service

Exhibition

PanelMate Regularly Participates In Embedded Exhibitions At Home And Abroad, Such As China International Industry Fair, German SPS Exhibition, International Embedded Exhibition, Photovoltaic Exhibition And So On.



Certification

PanelMate Can Work Directly With Laboratories Or Assist Customers In Obtaining Certifications, Including CCC, FCC, CE, ROHS And Import Certification For Specific Regions.



Quality Management System Certification ISO 9001:2015



MPG Patent Design License



Certification Of Trademark Registration In EU Area



Industrial Monitor CE Certification



CNC Control Panel CE Certification



Wall-Mounted BOX PC CE Certification

Partner

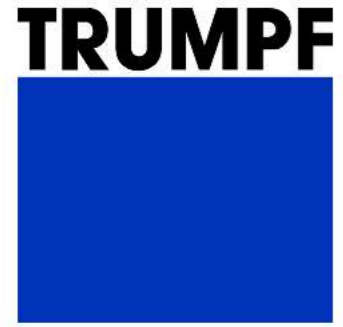

BECKHOFF

SIEMENS



Global Market

Europe

Italy
Croatia
Serbia
Spain
Poland
Holland
Turkey
Russia
Finland
Sweden

North America

Mexico
America
Canada

South America

Brazil
Chile

Asia

China
India
Japan
Israel
Iran
Russia
Kazakhstan
Indonesia

Africa

Morocco
Algeria
Nigeria

Austrilia

Australia





Powerful, Beautiful
No Exceptions



Add Buiding 18th, No.177 FuLian 2nd Road, BaoShan District, Shanghai
Tel 021-54851801
Net www.panelmate.cn

